

ABS-Lock[®] X-H-16

LX-H-XXX-16

MoA 201-10



DIN CEN/TS
16415:2017



DIN EN 795:
2012, A

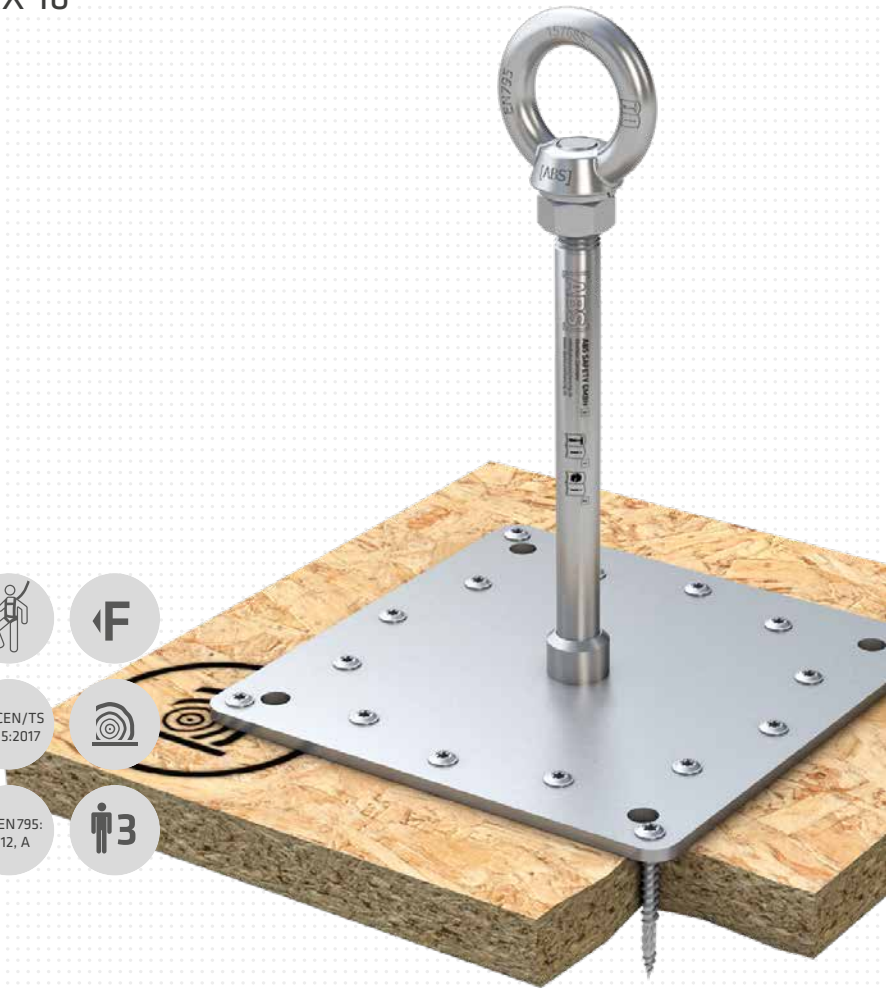

Werkzeuge | Tools



T30



24



24

Sicherheitshinweise | Safety instructions



- DE** Montageanleitung beachten (1) und Sicherheitshinweise beachten (2).
- EN** Comply with the installation manual (1) and Comply with the safety instructions (2).
- FR** Respecter la notice de montage (1) and Respecter les consignes de sécurité (2).
- NL** Montagehandleiding in acht nemen (1) and Veiligheidsinstructies in acht nemen (2).
- BGR** Спазвайте инструкциите за монтаж (1) and Спазвайте инструкциите за безопасност (2).
- DK** Følg monteringsvejledningen (1) and Følg sikkerhedshenvisningerne (2).
- ET** järgida montaažijuhendit (1) and järgida ohutusjuhiseid (2).
- FI** Noudata asennusohjeita (1) and Noudata turvallisuusohjeita (2).
- IT** Rispettare le istruzioni di montaggio (1) and Rispettare le istruzioni di sicurezza (2).
- PL** Przestrzegać zaleceń instrukcji montażu (1) and Przestrzegać zasad bezpieczeństwa (2).
- SK** Dodržujte návod na montáž (1) and Dodržujte bezpečnostné pokyny (2).
- SL** Sledite navodilom za namestitve (1) and Sledite varnostnim navodilom (2).
- ES** Observar las instrucciones de montaje (1) and Observar las indicaciones de seguridad (2).
- CS** Dodržujte návod k montáži (1) and Dodržujte bezpečnostní pokyny (2).
- HU** Vegye figyelembe az összeszerelési útmutatót (1) and Vegye figyelembe a biztonsági utasításokat (2).

Kontakte | Contact persons

Vertrieb & Technische Beratung
Sales & Technical Support
+49 (0) 28 32 - 972 81 - 0
vertrieb@absturzsicung.de

Schulung
Training
+49 (0) 28 32 - 972 81 - 254
schulung@absturzsicung.de

Montagevorbereitung
Assembly
+49 (0) 28 32 - 972 81 - 260
service@absturzsicung.de

Mustertypenschild | Sample label

[ABS]

ABS SAFETY GMBH 3

Kevelaer, Germany
info@absturzsicung.de
www.absturzsicung.de

1
2

Mustertypenschild /
Sample only

Chargennummer /
Batch number

6 Normen / Standards -

7 Max. Nutzer gleichzeitig (DIN EN 795:2012) -

Max. No. of simultaneous users

11 Modellnummer / Model number -

- -

- -

- -

8

9

10

Inhalt | Content



ABS-Lock X-H-16



ABS-Lock X-H-16





Montageschritte dokumentieren

Document assembly step

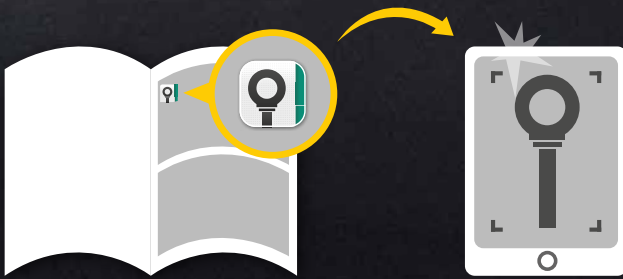

abs.lock-book.com







150 - 600
mm



min.
100
mm



min.
120
mm

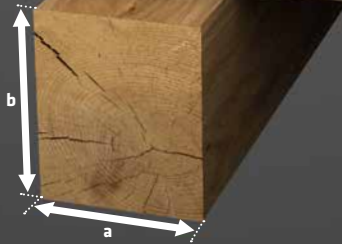

OPTIONAL
max. 3 mm



min.
22
mm





a \longleftrightarrow **13,5**
cm

b \longleftrightarrow min.
67,5
cm

c \longleftrightarrow min.
250
cm

Falls nicht vorhanden



a

b

c

min. **5x**

min. **5x**

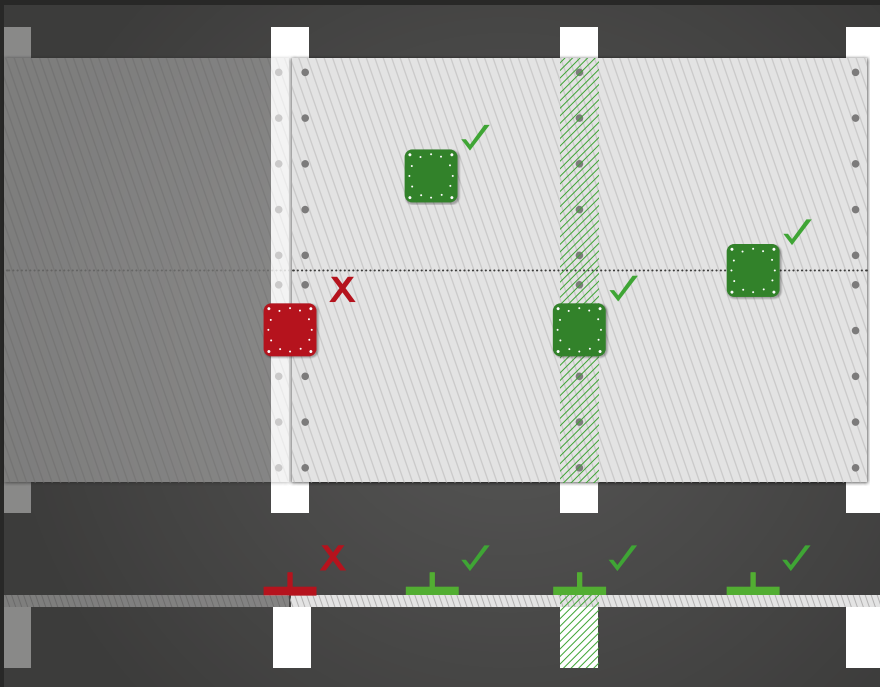



a   **OPTIONAL**
max. **10 mm**

b  min. **18 mm**
OSB 3

b  min. **24 mm**

12 13 **OSB 3** ≥ 12 mm
Holz/Wood ≥ 20 mm



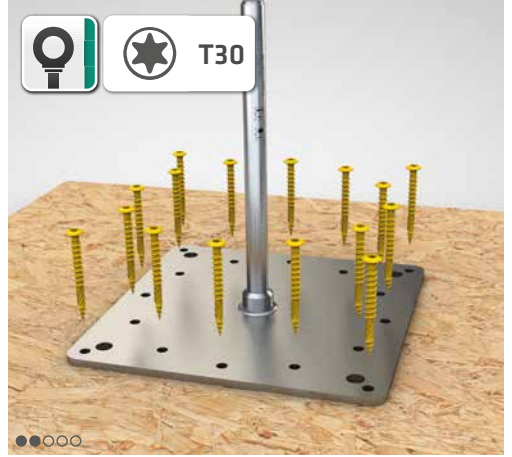

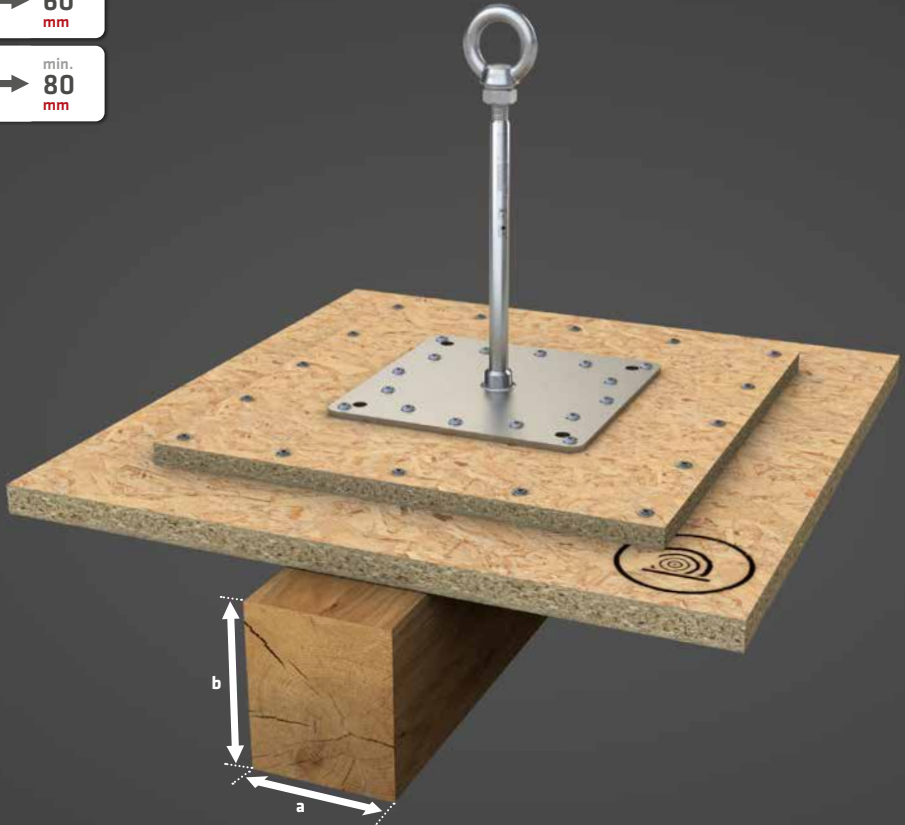

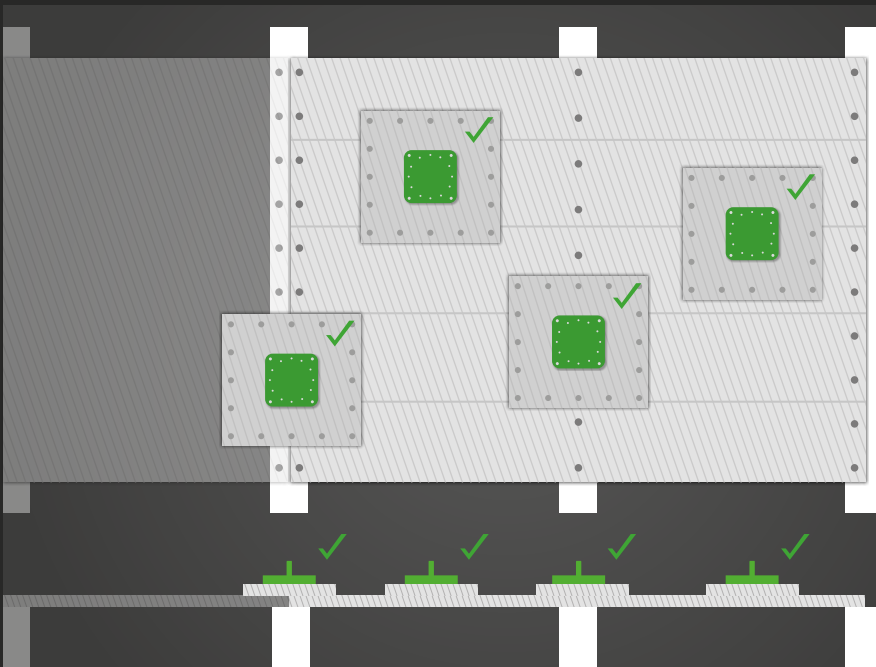
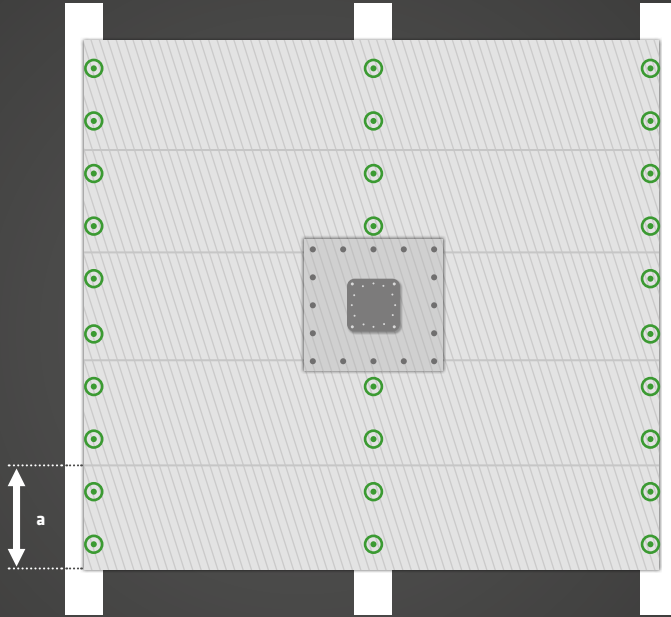
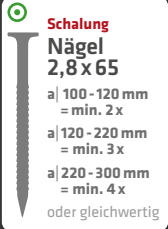

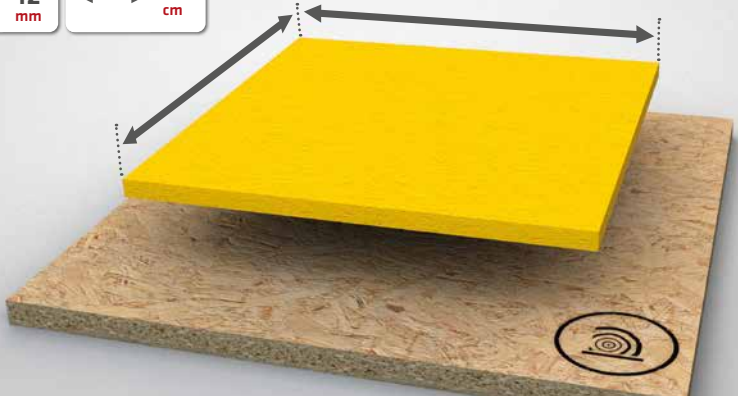

●○○○○○

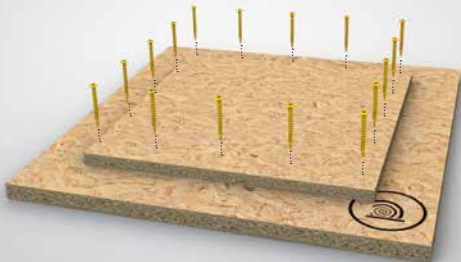

●●○○○○○



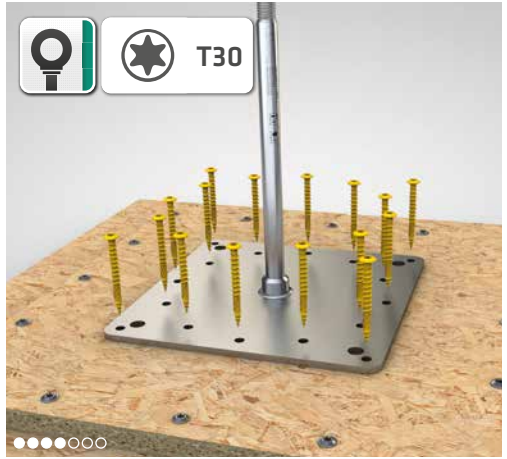

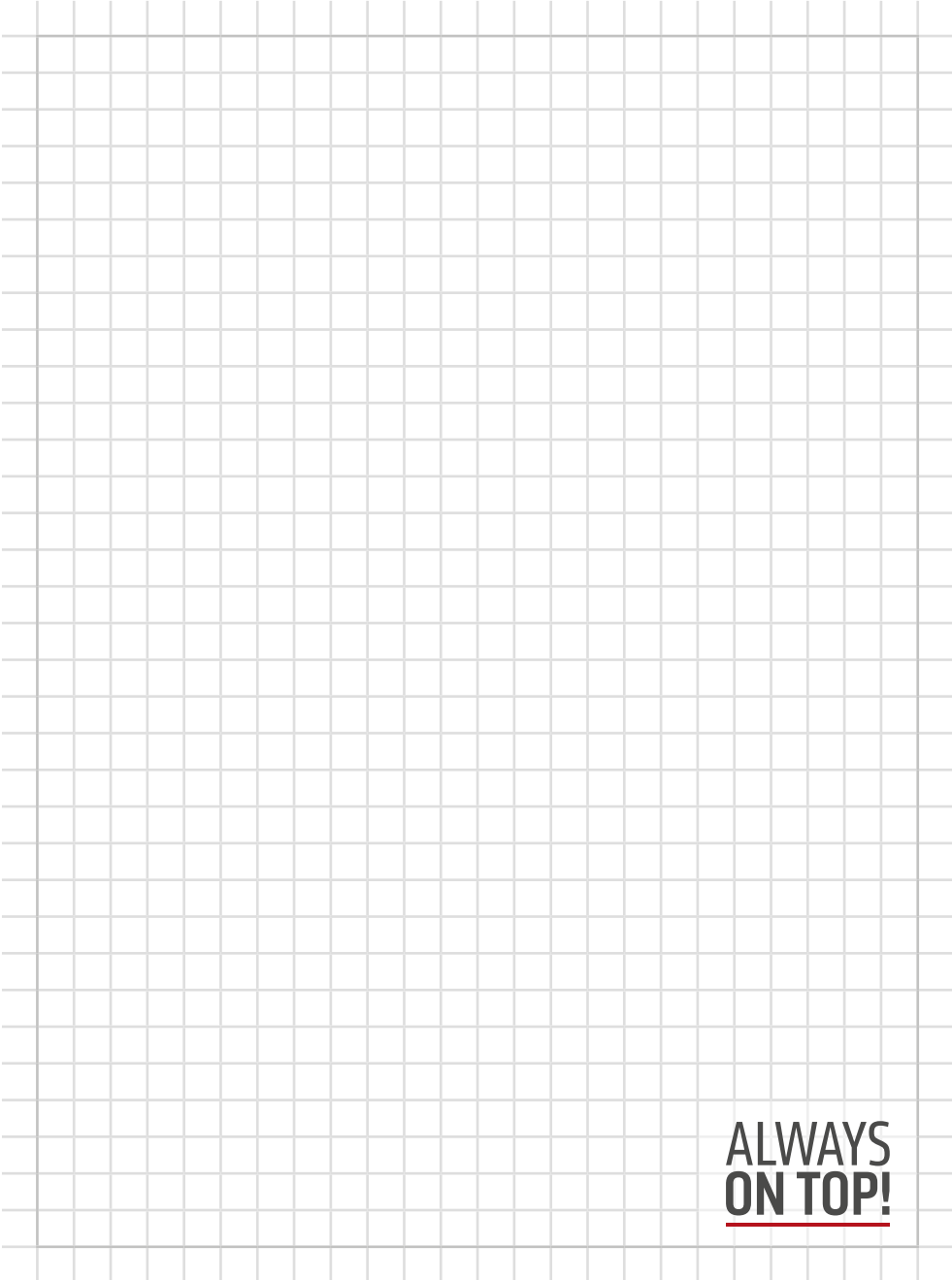

**ALWAYS
ON TOP!**

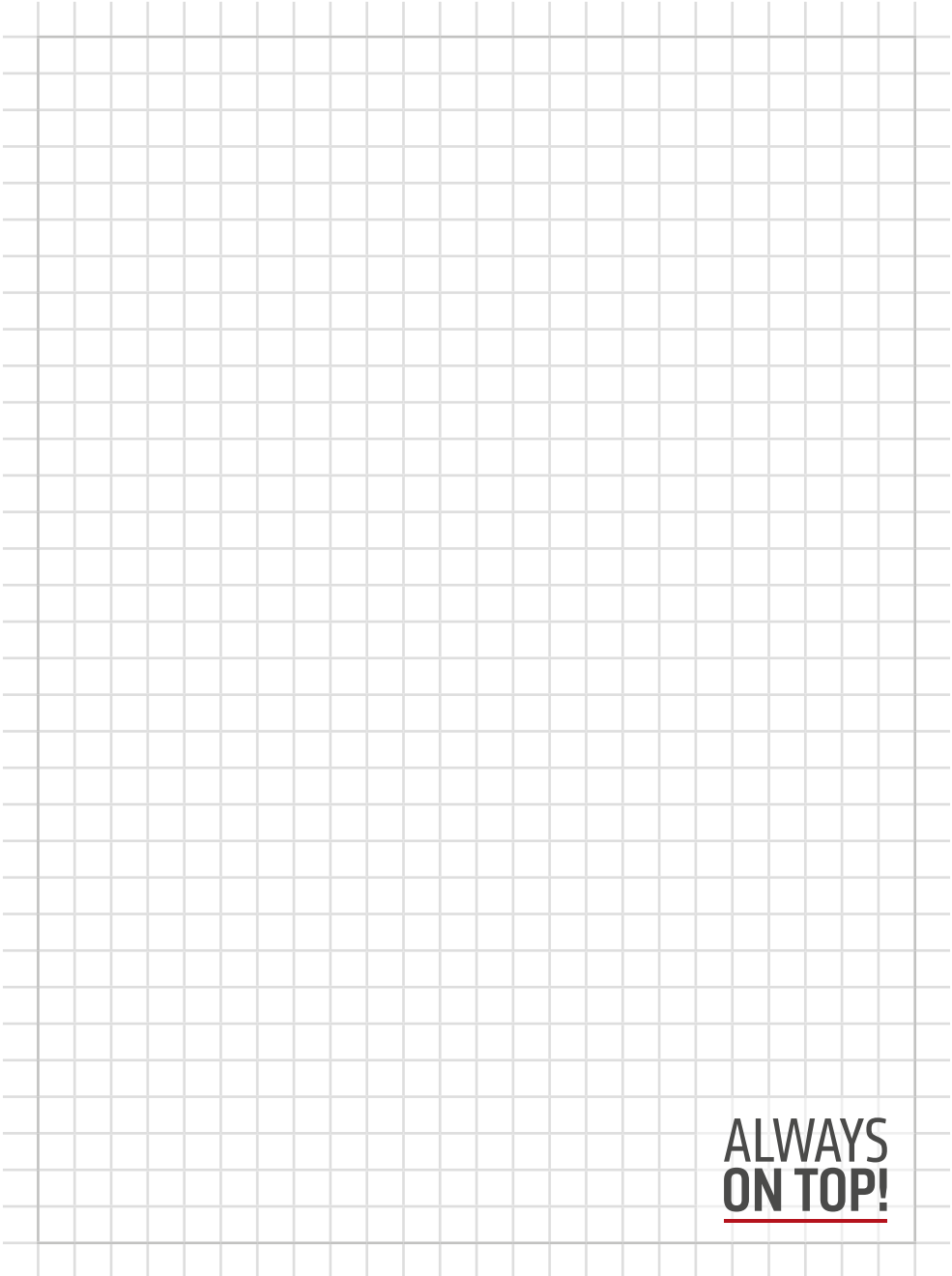

**ALWAYS
ON TOP!**

ALWAYS ON TOP!

ABS Safety GmbH

Gewerbering 3
D-47623 Kevelaer
Germany

Tel.: +49 28 32 972 81 - 0
Fax: +49 28 32 972 81 - 285

info@absturzschutz.de

 www.absturzschutz.de

 .de/en

 .de/fr

 .de/nl

RS 5, November 2020



[instagram.com/abssafety](https://www.instagram.com/abssafety)



[youtube.com/abssafetygmbh](https://www.youtube.com/abssafetygmbh)



[facebook.com/ABS.Safety](https://www.facebook.com/ABS.Safety)